

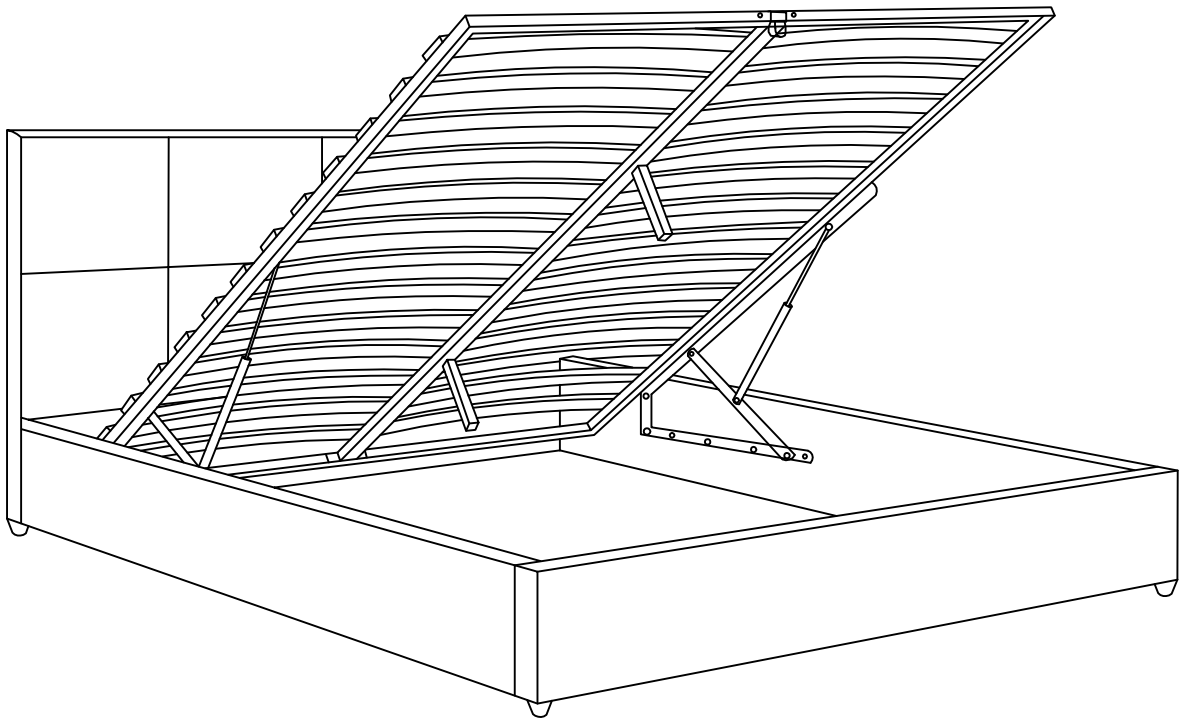

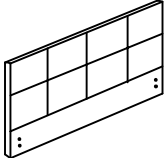

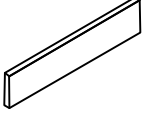

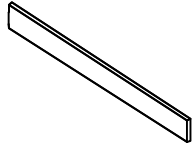

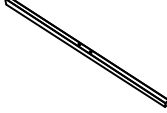



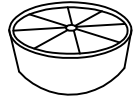

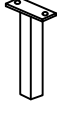
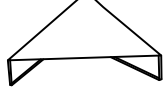
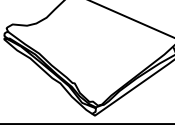
ASSEMBLY INSTRUCTIONS

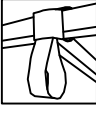

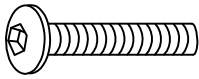
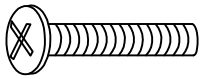

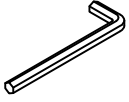
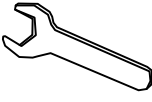
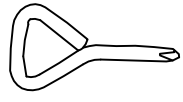

Parts List

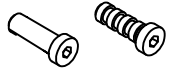
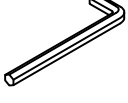
A HEAD BOARD 1PC 	B FOOT BOARD 1PC 	C SIDE RALL 2PCS 	D BEDSTEAD RAIL 2 SETS 
E BEDSTEAD RAIL 2 SETS 	F SLAT 3 0 PCS 	G Single Plastic Cap 3 0 pcs 	H Double Plastic Cap 15pcs 
I LEG 4 PCS 	J 4 PCS 	K Support Leg 2 PCS 	L 2 pcs 
M Non-woven fabrics 1pc 	N 1 PCS 	O Center Support Bar 1pc 	P Digging rope 1PC 

Hardware List



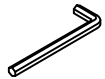

1 M8*30 x16 PCS 	2 M8*40 x 14 PCS 	3 14 pcs 	4 8 pcs 
5 8 pcs 	6 M5 x1 PC 	7 1 pcs 	8 1 pcs 
9 M4*25 x 4 PCS 	10 M6*20 x 8 PCS 	11 M4 x 2 PCS 	

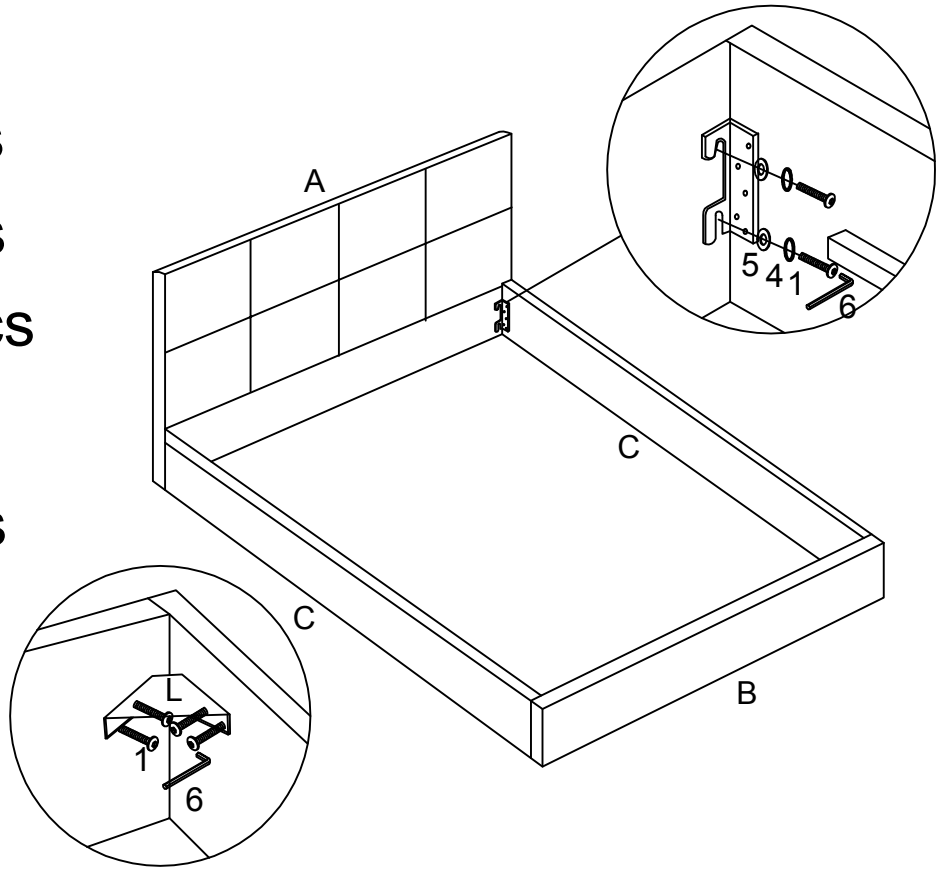
Step1

- 5  8pcs
- 4  8pcs
- 1  16pcs
- 6  1pc
- L  2pcs

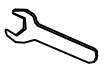

Step2

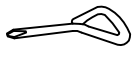
- J  4 pcs
- 2  4 pcs
- 3  4 pcs
- 7  1 pc
- 10  8pcs
- 11  2pcs
- 8  1 pc

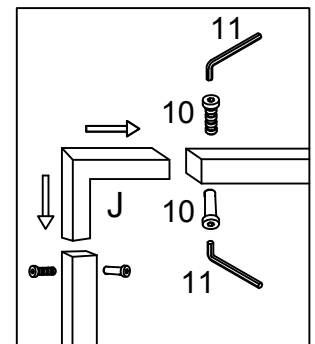
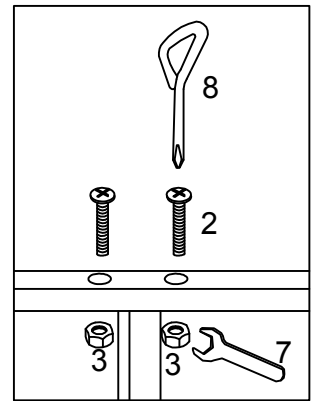
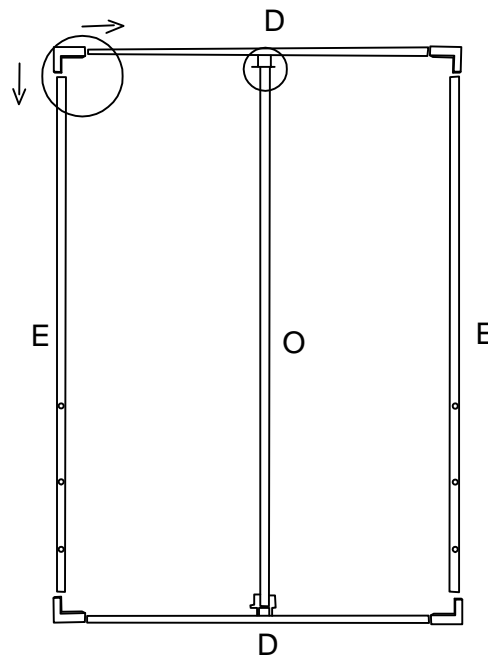

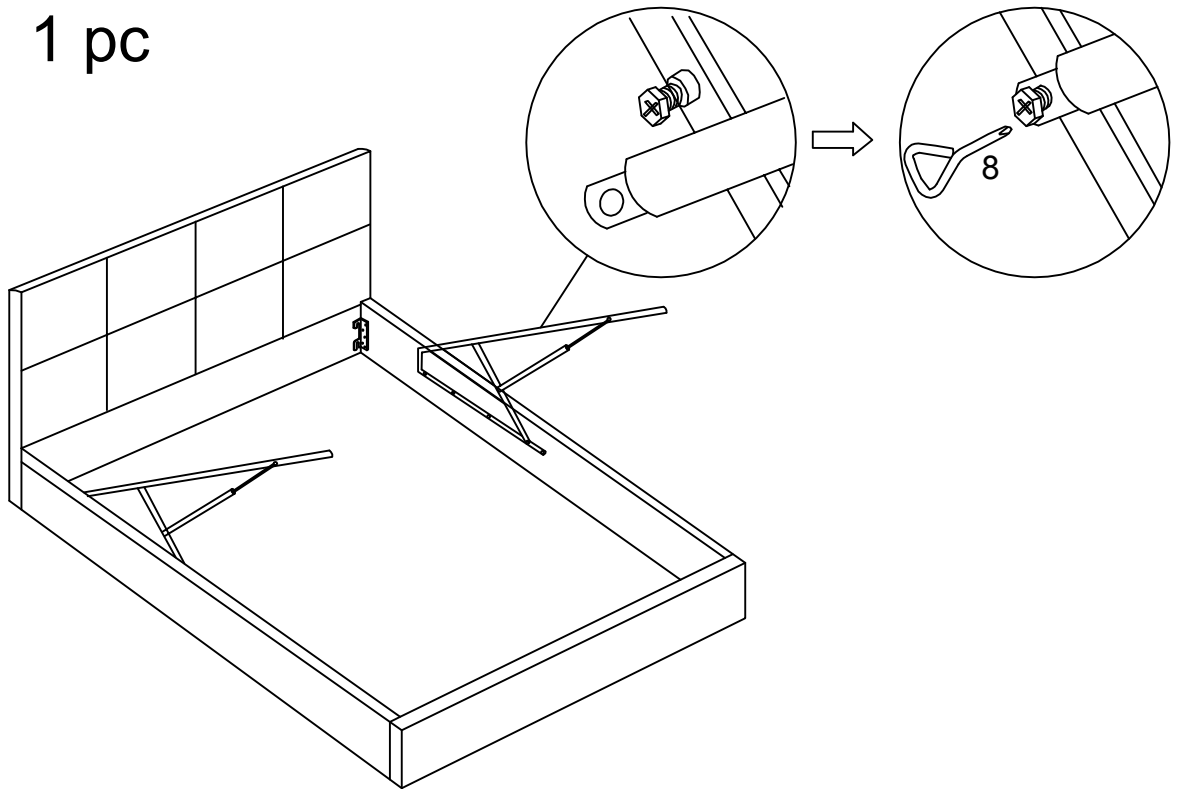

Step3

8  1 pc

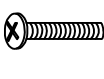

Step4

2  10 pcs

3  10 pcs

7  1 pc

8  1 pc

K  2 pcs

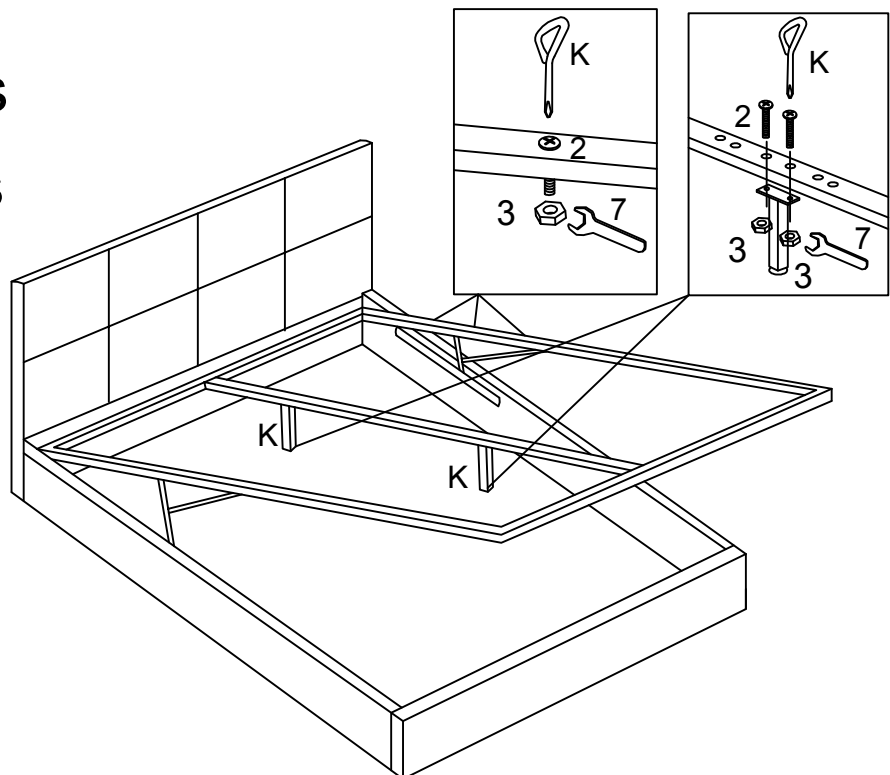

Step5

P  1 pc

N  1pc

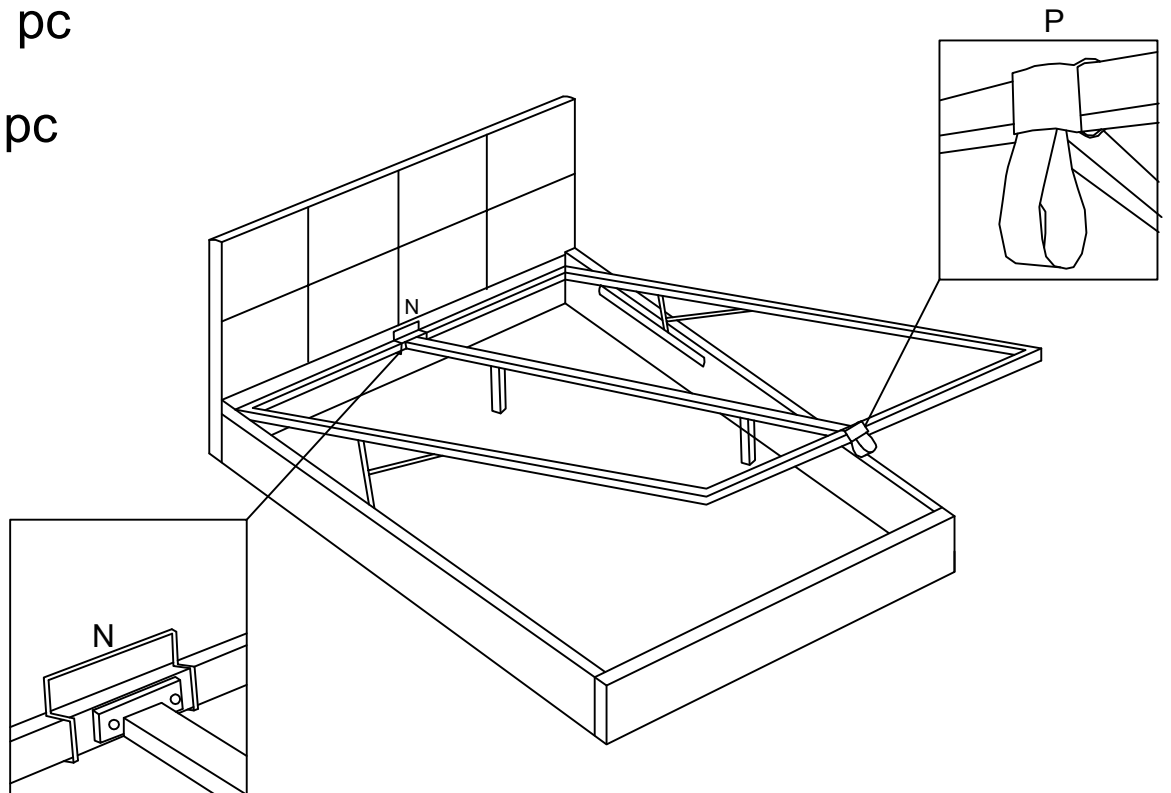

Step6



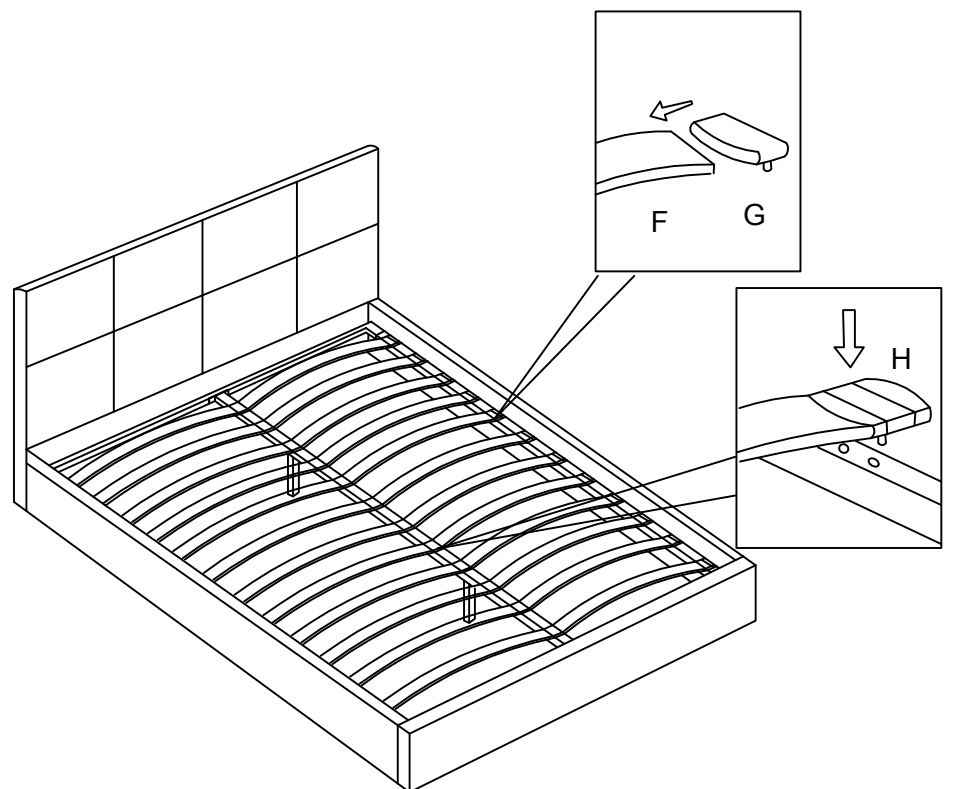

F  30pcs

G  30pcs

H  15pcs



Step7

- M  1 pc
- I  4 pcs
- 8  1 pc
- 9  4 pcs

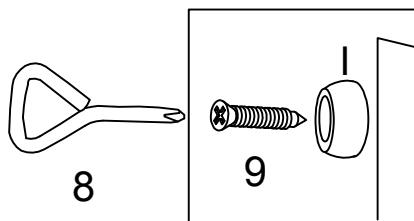
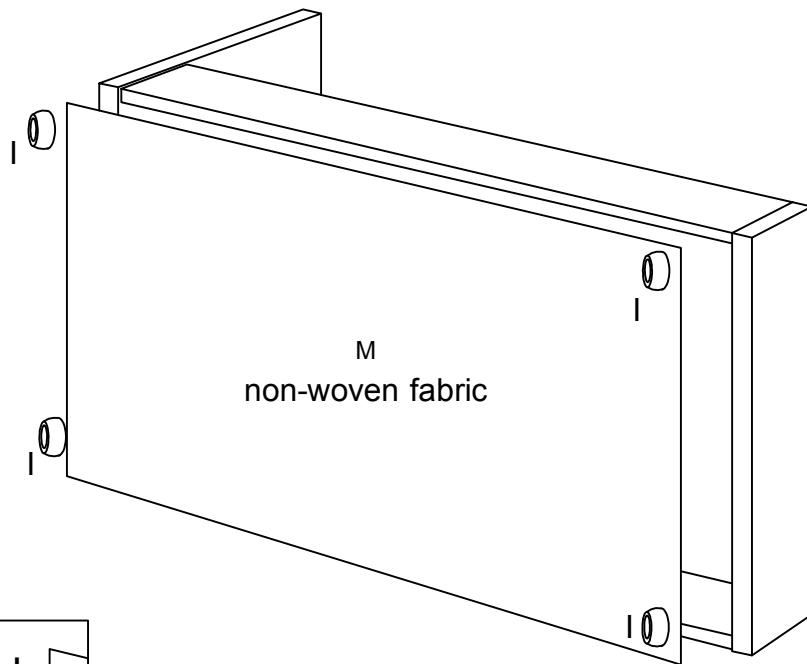

Stick the non-woven fabric on bottom and them assemble the 4 foot

Step8

